



MANUFACTURED BY ARIBEX

GETTING STARTED

This quick reference guide is intended to supplement the *Operator Manual* and operator training materials located on the *NOMAD Pro Operator Manual CD*.

NOTE: The manual and training materials are also available for download on the Aribex website at www.aribex.com or they can be ordered in hard copy format: support@aribex.com

1 Unwrap each component from the protective plastic and check for any noticeable signs of damage – do not use the device if it shows signs of damage.

The standard package system includes the following items.

- NOMAD Pro X-ray Head,
- 2 Handsets,
- Battery Charger Cradle,
- AC to DC Power Supply,
- Certificate of Conformance,
- Warranty Card, and
- NOMAD Pro Operator Manual CD.

2 Verify that the serial number on the Warranty / Registration card matches the X-ray head serial number and the device serial number on the carrying case.



3 Please complete the product Warranty / Registration card and mail it with proper postage to Aribex today. Completing the card fulfills a condition of warranty coverage.



Review the Operator Manual and training material contained on the CD shipped with this device.

BASIC OPERATION

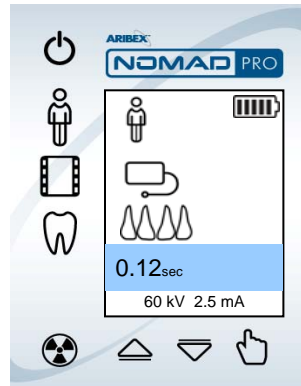
- 1 Attach a fully charged handset.
- 2 Turn the power on by pressing the Power (⏻) button.
- 3 Select Patient Size (Adult or Child .
- 4 Select Image Receptor type (Film , Phosphor Plate , or Sensor .
- 5 Select the Tooth Group (Anterior , Posterior , or Bitewing).
For more on adjusting the time settings see the *Operator Manual* contained on the CD.
- 6 Position the NOMAD Pro relative to the receptor.
- 7 Pull and release the trigger once to put the NOMAD Pro into the **READY** state.
- 8 Pull and hold the trigger (a second time) until the **X-RAY COMPLETE** is displayed and the audible tone indicates the exposure is done.
- 9 Turn off the power by pressing the Power (⏻) button.

Do not operate NOMAD Pro or the handset, charger cradle, or AC power supply if equipment was subjected to moisture. Do not spray disinfectant or cleaners directly on the NOMAD Pro, handset, charger cradle or AC power supply. Damage to your device or a shock hazard may result. Consult the Operator Manual on the CD for proper cleaning instructions.



Do not open the housings. Doing so will void the warranty. There are no user-serviceable parts inside the NOMAD Pro, handset, charger cradle or AC power supply. Locate the charging system away from the normal patient environment. NOMAD Pro should not be operated if it has been dropped or performance degrades; it should be returned to Aribex for a safety check.

HANDSET (BATTERY) CARE

The following are important handset care notes:

- Each handset can go through the full discharge/charge cycle approximately 300 times. Routinely change out a discharged handset with fully charged one as needed.
- The handset can be left indefinitely on the charging cradle without damaging batteries, unless AC power to charging cradle is completely interrupted or indicator lights illuminate orange when handset is first placed on charging cradle.
- Battery charge will diminish during extended inactivity – **fully recharge handsets every 3 months during inactivity**. Never place a low charge battery into long-term storage.
- Do not store handsets in extreme conditions: below -20°C (-4°F) or above +60°C (+140°F), or beyond 95% relative humidity (non-condensing). The optimal storage location is cool, dry, and away from direct sunlight.
- Do not store or carry handsets so that conductive objects can contact exposed battery contact springs.
- When the charging cradle senses a bad handset battery, the indicator lights will illuminate red rather than green. In this case, the batteries are inoperable and must be serviced.
- Handset communications and mechanical integrity are checked by pulling the handset trigger when it is on the charging cradle – good communication exists when the indicator lights illuminate orange.



Do not attempt to charge a handset with damaged batteries. Risk of fire or explosion exists if batteries inside the handset are replaced by unauthorized service personnel; do not use batteries from other sources. Properly dispose of spent or damaged handset; return to Aribex or an authorized distributor for replacement and recycling. Do not place in municipal waste stream.

LIMITED WARRANTY

COVERAGE. Aribex, Inc. warrants its medical and dental x-ray equipment to be free from any defects in material or workmanship for a period of one (1) year from the date of purchase. Aribex, Inc. also warrants any accessories purchased from Aribex to be free from any defects in material or workmanship for the period of one (1) year from the date of purchase.

The liability of Aribex, Inc. is limited to repair or replacement of any parts that Aribex or its authorized resellers determine to be defective. Contact Aribex for a Return Material Authorization (RMA) number and shipping instructions. Parts proving defective shall be repaired or replaced free of charge (labor and domestic shipping included), if defective equipment is returned freight collect to Aribex (Utah, USA) or the location of the authorized service center. Equipment repaired or replaced under warranty shall continue to be warranted for the balance of the original warranty term. All warranty claims must be made not later than ten (10) business days following the expiration of the applicable warranty period.

LIMITATIONS OF COVERAGE. This warranty does not apply to equipment that is or has been abused, misused, or altered (including opening enclosure or tampering), improperly maintained, subjected to use beyond rated conditions, or damaged as a result of any carelessness or accidents. This warranty does not cover ordinary wear and tear or maintenance.

LIMITATIONS OF LIABILITY. Aribex, Inc. makes no other warranty, either expressed or implied, with respect to any equipment purchased from Aribex, including without limitation any implied warranties of merchantability or fitness for a particular purpose, whether or not Aribex may have been informed of the actual uses to which any of such equipment may be put. Aribex, Inc. shall not under any circumstance be liable for incidental, indirect, consequential, punitive or exemplary damages, including without limitation damages for delay or lost profits, and in no event shall liability of Aribex arising from the purchase, sale or use of the equipment, or breach of any warranty made above, exceed in the aggregate the purchase price paid therefore.



0473
ISO 13485 / ISO 9001
CERTIFIED COMPANY



MT Promed Consulting
Altenhofstr. 80
66386 St. Ingbert
Germany

Aribex, Inc.
744 South 400 East
Orem, Utah 84097
U.S.A.



Phone: 801-226-5522
Fax: 801-434-7233
Email: NOMAD@aribex.com
<http://www.aribex.com>

U.S. patents 7,224,769 and 7,496,178
United States and international patents pending
© Aribex, Inc. 2005, 2010
All Rights Reserved

MP-0075-D

THE NOMAD[®] PRO

DIFFERENCE

NOMAD Pro is safe to be used as a handheld X-ray source. There is no need to leave the room during an exposure.

Aside from the direct beam, X-ray devices have two potential operator radiation sources: 1) leakage radiation and 2) backscatter radiation bouncing back off the subject.

1) **Leakage** – Unique internal shielding of NOMAD Pro encases the X-ray tube eliminating leakage radiation. As demonstrated by the data below, this makes it safe to use NOMAD as a handheld device during exposures.

2) **Backscatter** – When properly oriented, the transparent shield on NOMAD Pro collimator acts as a barrier against backscatter radiation, making it safe for the operator to stay in the room.

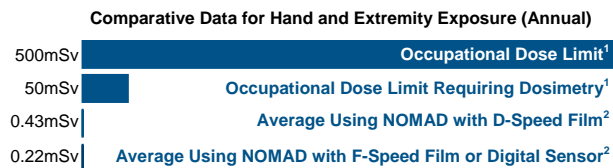
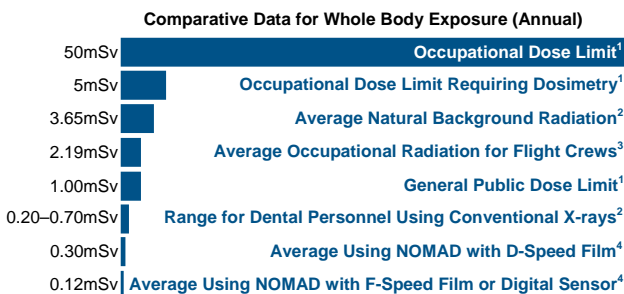
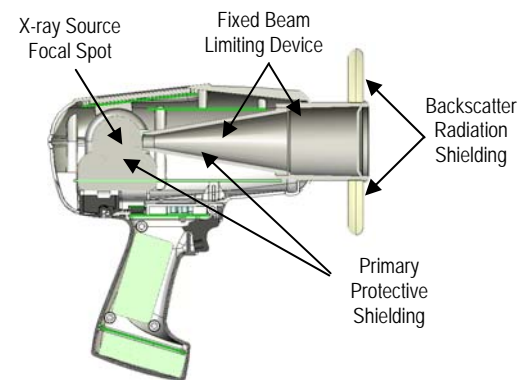

1) Standards for Protection against Radiation, 10 CFR 20 (US Federal Standards), 1994 (see also *NCRP Report No. 116*)
 2) *NCRP Report No. 145* (National Council on Radiation Protection and Measurements), p7-9
 3) "Estimated Cosmic Radiation Doses for Flight Personnel", Feng YJ et al, *Space Medicine and Medical Engineering*, 15(4) 2002, p265-9
 4) Normalized average assumes 7,200 exposures per year, and the average length of exposure for D-speed = 0.50 seconds, F-speed = 0.25 seconds, digital sensor = 0.20 seconds

As a result of the internal and backscatter shielding, operator X-ray exposure is far below federal regulatory limits.

RADIATION SAFETY

- ❖ Operators must follow all applicable regulatory guidelines and in-house radiation protection program in regard to patients and operators who are pregnant or expect to become pregnant.
- ❖ Operators must be fully acquainted with industry safety recommendations and established maximum permissible doses.
- ❖ Do not enable NOMAD Pro until patient and operator are positioned and ready for the exposure, preventing interruption and inadvertent exposure of anyone to X-rays.
- ❖ Do not attempt an exposure if anyone other than patient is in the direct beam. If others are assisting, then they should wear protective covering.
- ❖ When selecting and using Position Indicating Devices (PIDs), preference should be given to models that allow the backscatter shield to remain at the outer end of the collimator cone for maximum operator protection.
- ❖ An exposure can be terminated for any reason by abruptly releasing the depressed trigger.
- ❖ Optimal operator radiation backscatter protection exists when:
 - The backscatter shield is positioned at the outer end of the collimator cone.
 - The backscatter shield is close to the patient.
 - The patient tilts their head when needed to accommodate exposures.
 - The operator remains within the significant zone of occupancy immediately behind the device shield.
- ❖ As shown in graphic representations, maximum protection (green area) from backscatter radiation (red area) exists when the NOMAD Pro is positioned near the patient, is perpendicular to the operator with the patient (oval) positioned/tilted as needed, and the backscatter shield is fully extended toward the patient.

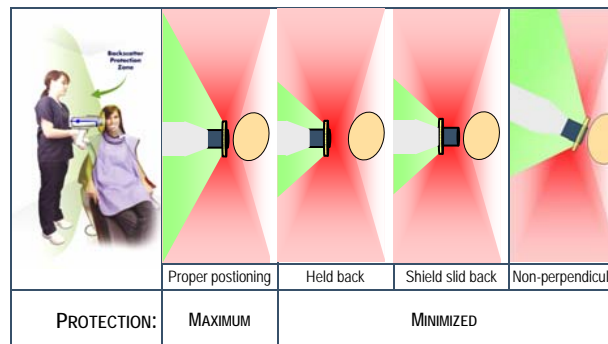

- ❖ Operation outside the protection zone (or with a diminished protective zone) requires proper precautions such as the use of lead aprons.

ALARMS AND ALERTS

Alert	Function / Resolution
ENABLING X-RAYS	Initiated by a single pull and release of the trigger, within 1 second. If no further action is taken the device will shift into the READY state. Do not pull trigger again until the READY state is indicated.
No audible signal	
READY	READY message will display on-screen following the ENABLING X-RAYS message. The READY state will last for 15 seconds, or until one of the buttons on the user interface panel is pressed, or until the exposure is initiated by a second pull of the trigger.
0.20sec ...	
Double ascending tone	
X-RAYS ON	At the end of the successful exposure the yellow LED turns off, and display panel briefly indicates X-RAY COMPLETE and the screen returns to the normal mode.
0.20sec	
Single tone during exposure	
Alarm	Function / Resolution
COOLING DOWN [count down]	Initiated if the operator presses the trigger to activate the READY state before the duty cycle time has lapsed. Countdown timer will be displayed showing time remaining until normal operation mode resumes.
Double tone at the start and end of cool down	
RECHARGE HANDSET	Ensure the Handset is locked in place. If battery voltage is lower than required for the X-ray exposure, the device will not allow the exposure. Replace the current handset with a freshly charged handset.
5 audible tones	
INCOMPLETE (PRESS ANY KEY)	Activates if trigger is released before the timed X-ray exposure finishes. This condition is cleared by pressing any button on the user interface panel or by tuning the power off then on.
0.38sec	Depress the trigger for the duration of the exposure time.